

RAVEN RATE CONTROL MODULE

RATE CONTROL MODULE, GEN 1 ISOBUS HARNESSING

KIT P/N 117-7100-006 (LEVEL 2), 117-7100-005 (LEVEL 1), 117-7100-004 (LEVEL 0)

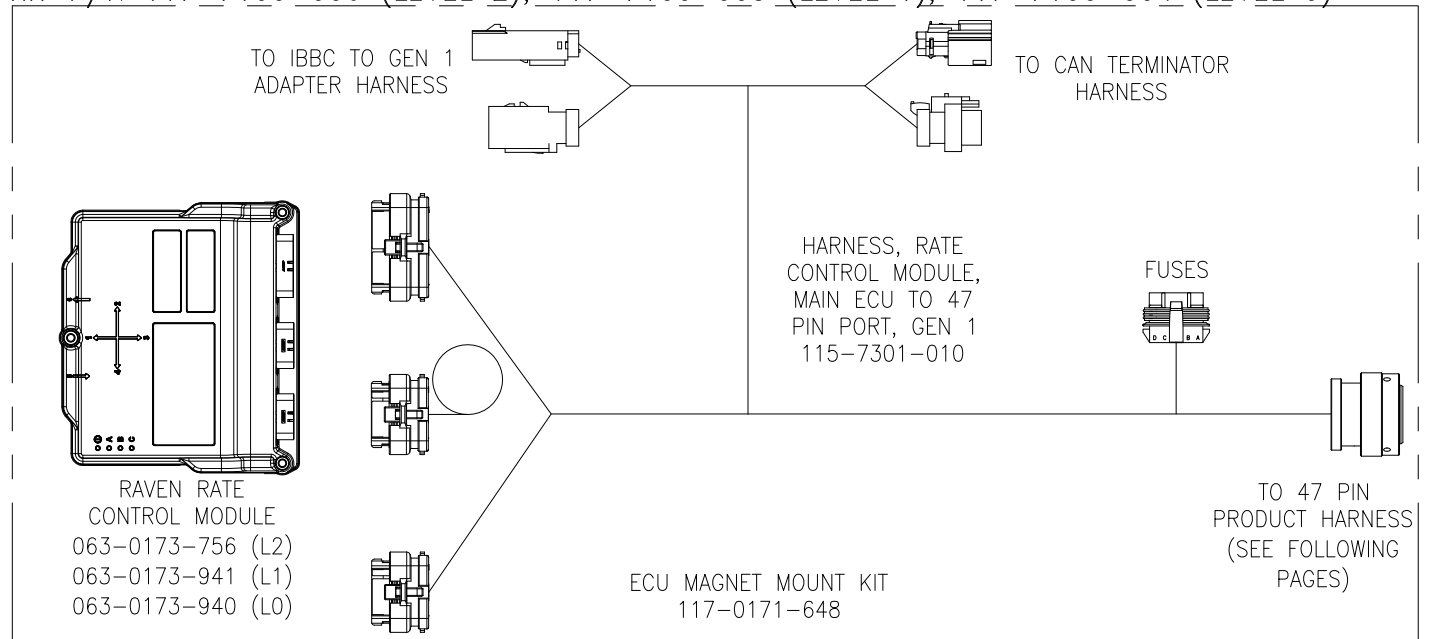

RATE CONTROL MODULE, GEN 3 ISOBUS HARNESSING

KIT P/N 117-7100-003 (LEVEL 2), 117-7100-002 (LEVEL 1) OR 117-7100-001 (LEVEL 0)

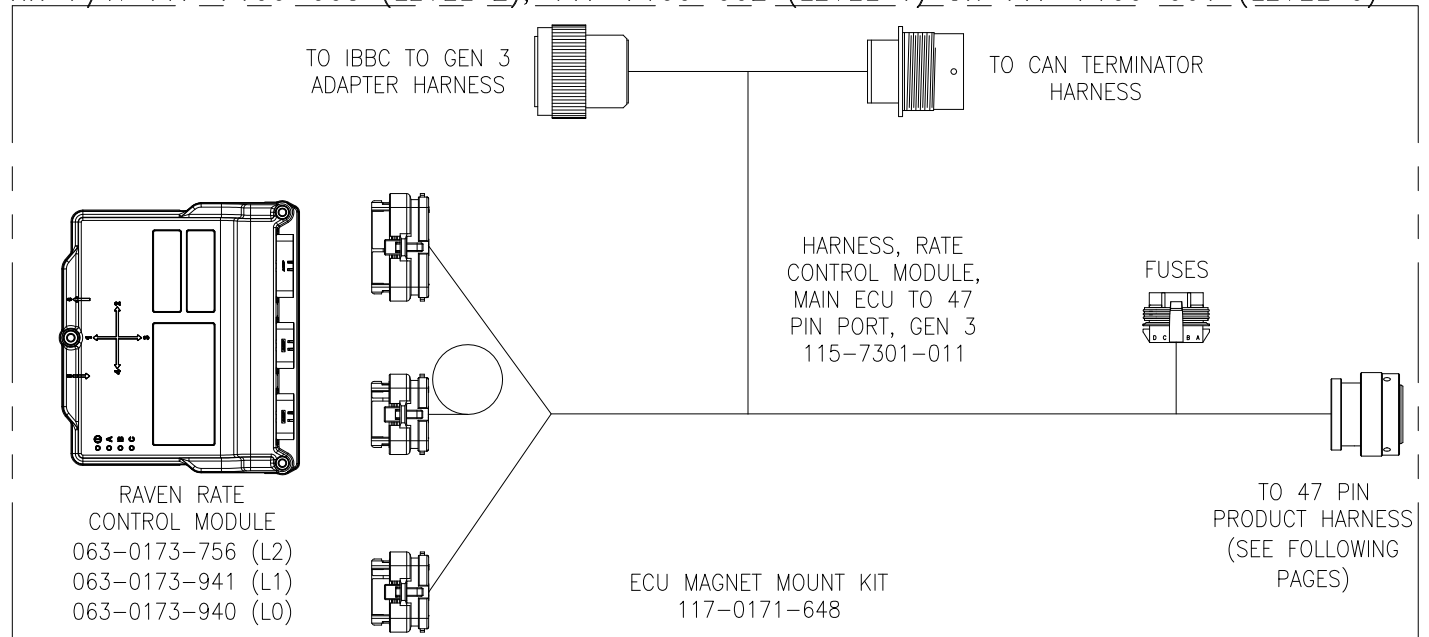

NOTES:

1. RCM KIT INCLUDES ECU, MAIN ECU HARNESS, AND MAGNET MOUNTING KIT. OPERATOR'S MANUAL AVAILABLE ONLINE.

2. ORDER SEPARATELY:

A) IBC TO GEN 1 OR GEN 3 ISOBUS ADAPTER HARNESS AND CAN TERMINATOR:
REFERENCE 054-7000-002

B) MASTER/SECTION SENSE OPTIONS
SEE PAGE 2

C) ISOBUS IMPLEMENT CONNECTOR (IF NOT EQUIPPED):
REFERENCE 054-7000-002

D) PRODUCT HARNESS
SEE FOLLOWING PAGES

E) OPTIONAL MOUNTING PLATE KIT
117-0171-680

F) OPTIONAL PRINTED OPERATOR'S MANUAL
016-0171-637

RELEASED DATE	ECO #	REV.	DRAWING NO.
8/29/17	29879	B	054-7100-003
9/14/17	29471	C	054-7100-003

RAVEN MASTER/SECTION SENSE OPTIONS

MASTER SWITCH OPTIONS

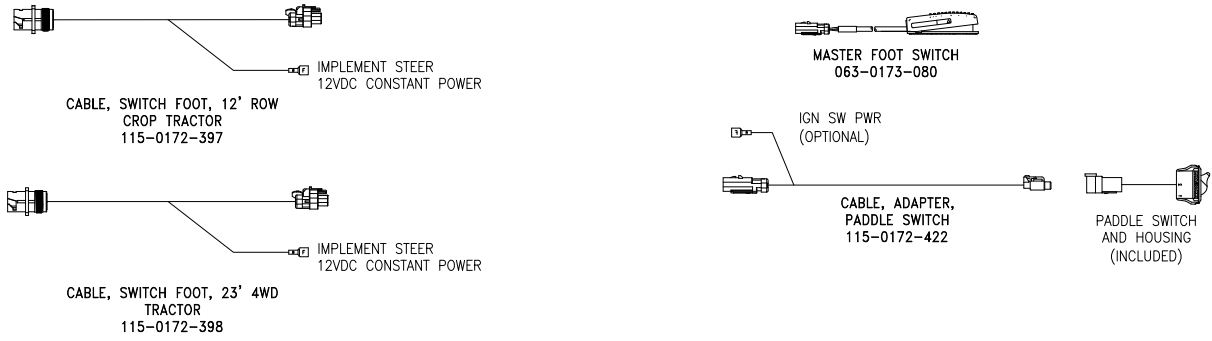

ISO SWITCHBOX (STAND-ALONE)

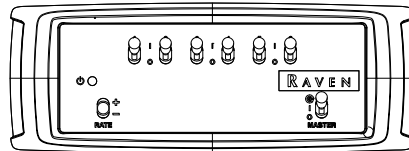

RAVEN ISO SWITCHBOX
117-6020-001

AVAILABLE KITS:

- FOR USE WITH RAVEN VIPER 4(+) 117-6020-004
- FOR USE WITH DEERE GS2630 117-6020-002
- FOR USE WITH CNH PRO 700/INTELLVIEW 117-6020-003

ECU INTERFACE TO PRE-EXISTING SWITCHES

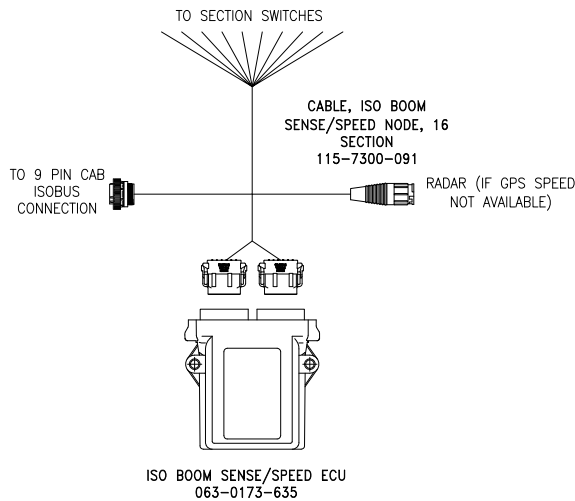

AUXILIARY ISOBUS DISPLAY

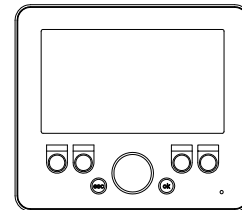
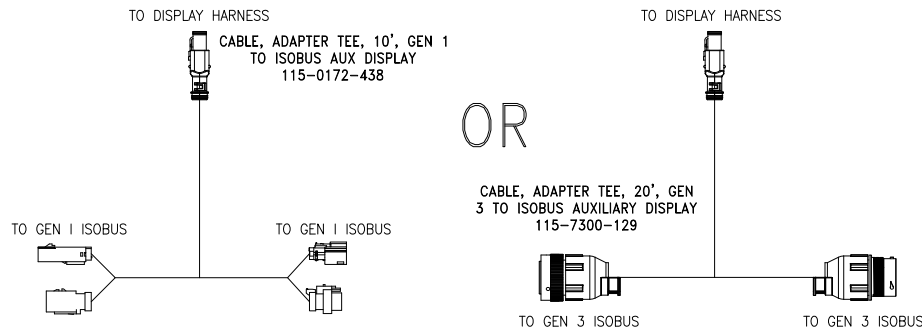

* KIT P/N 117-0171-702
CONTAINS DISPLAY, MOUNTING
BRACKET, AND DISPLAY
HARNESS

CONSOLE, ISOBUS AUXILIARY,
4.3" DISPLAY
063-0173-938

OPTIONAL RAM MOUNT KIT
117-0171-709

RELEASED DATE	ECO #	REV.	DRAWING NO.
8/29/17	29879	B	054-7100-003
9/14/17	29471	C	054-7100-003

RAVEN RCM SPRAYER/LIQUID APPLICATOR OPTIONS

GENERIC LIQUID HARNESSSES

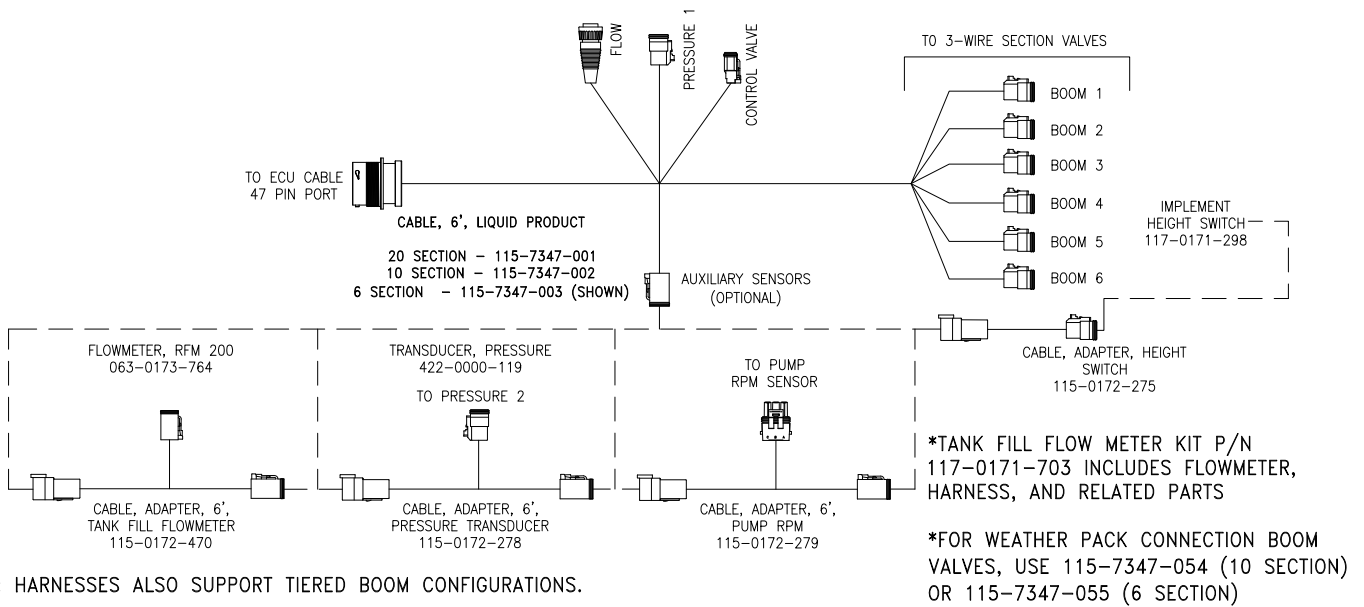

LIQUID SLURRY HARNESS

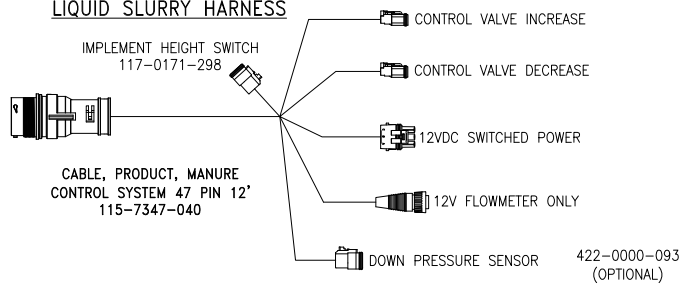

HARDI SPRAYER/ TWO-WIRE SECTION VALVE CONFIGURATIONS

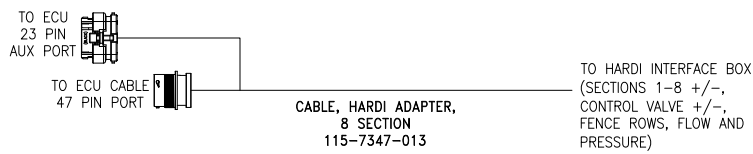

LIQUID PRODUCT 6 SECTION WITH BOOST BOX

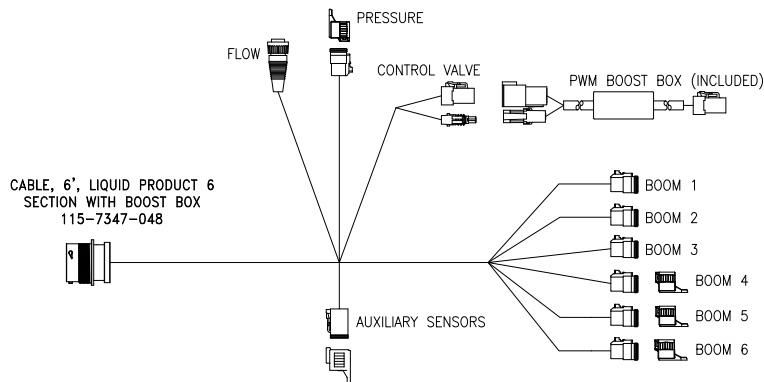

SIDEKICK PRO ICD
 REFERENCE DWG. 054-7120-002 FOR OPTIONS

RELEASED DATE	ECO #	REV.	DRAWING NO.
8/29/17	29879	B	054-7100-003
9/14/17	29471	C	054-7100-003

RAVEN RCM NH3/ACCUFLOW (HP+) OPTIONS

ACCUFLOW (HP+) PRODUCT HARNESSSES

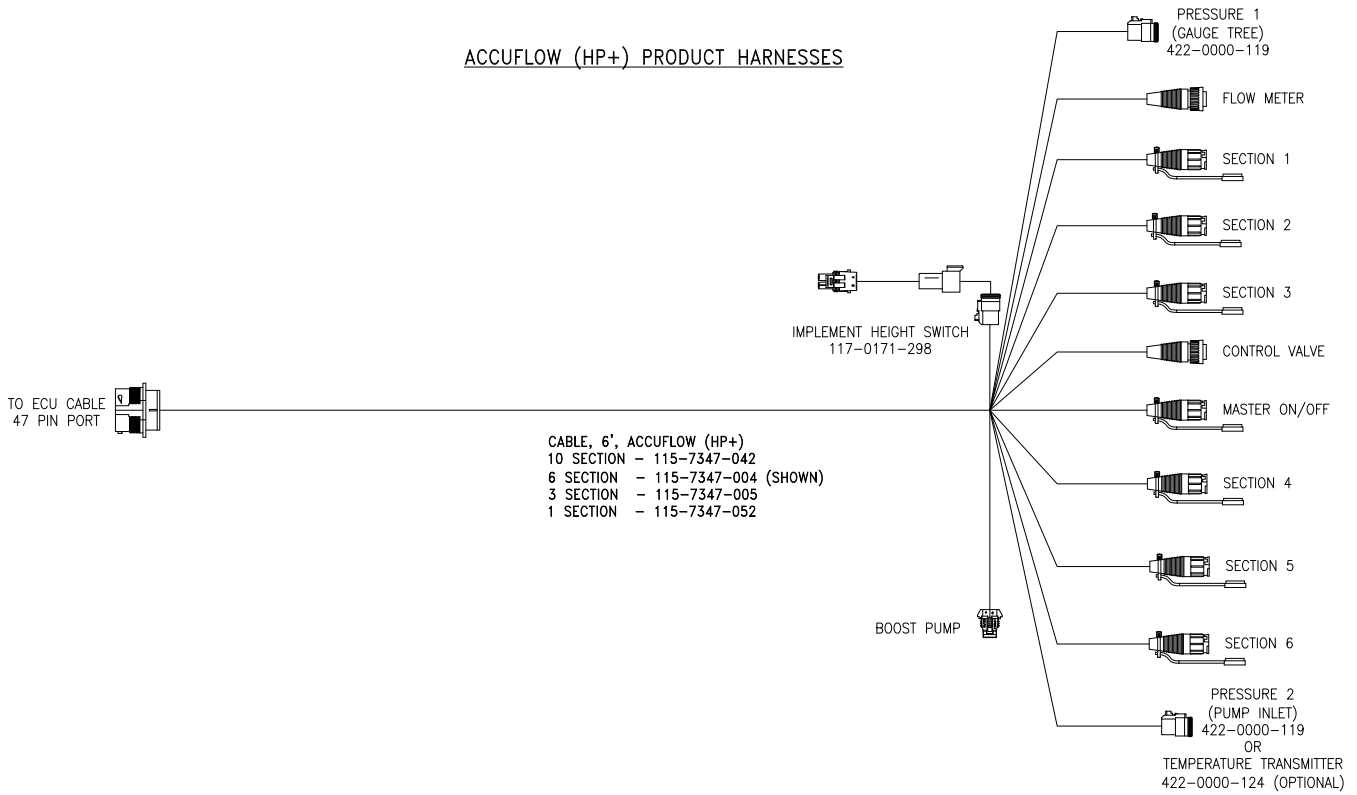

ACCUFLOW (HP+) HARNESS - MULTI-PRODUCT OPTION

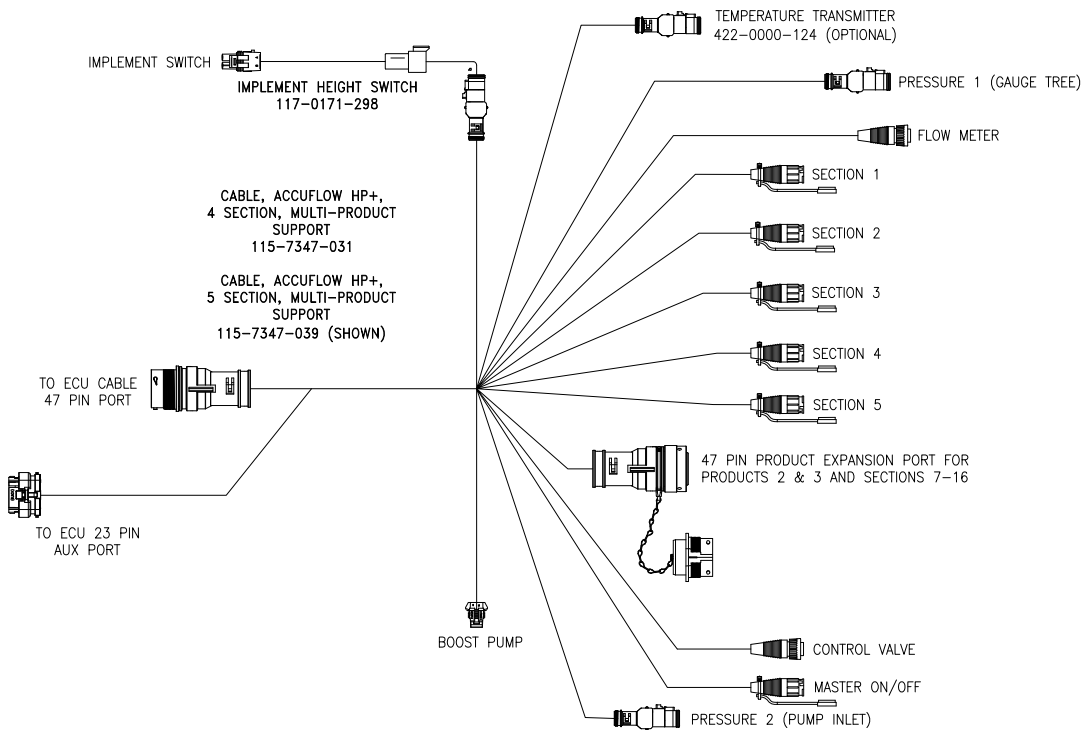

SIDEKICK PRO ICD
REFERENCE DWG. 054-7120-002 FOR OPTIONS

ACCUFLOW VORTEX (HP+)
REFERENCE DWG. 054-1201-001

RELEASED DATE	ECO #	REV.	DRAWING NO.
8/29/17	29879	B	054-7100-003
9/14/17	29471	C	054-7100-003

RAVEN RCM SPREADER OPTIONS

GENERIC SPREADER

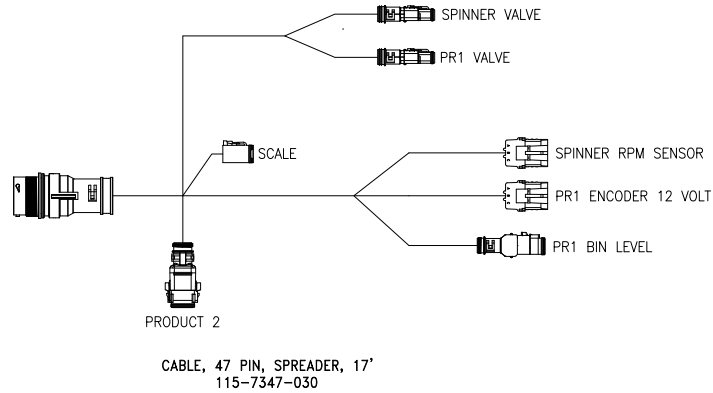

NEW LEADER 4000 SPINNER BOX (1-4 BINS)

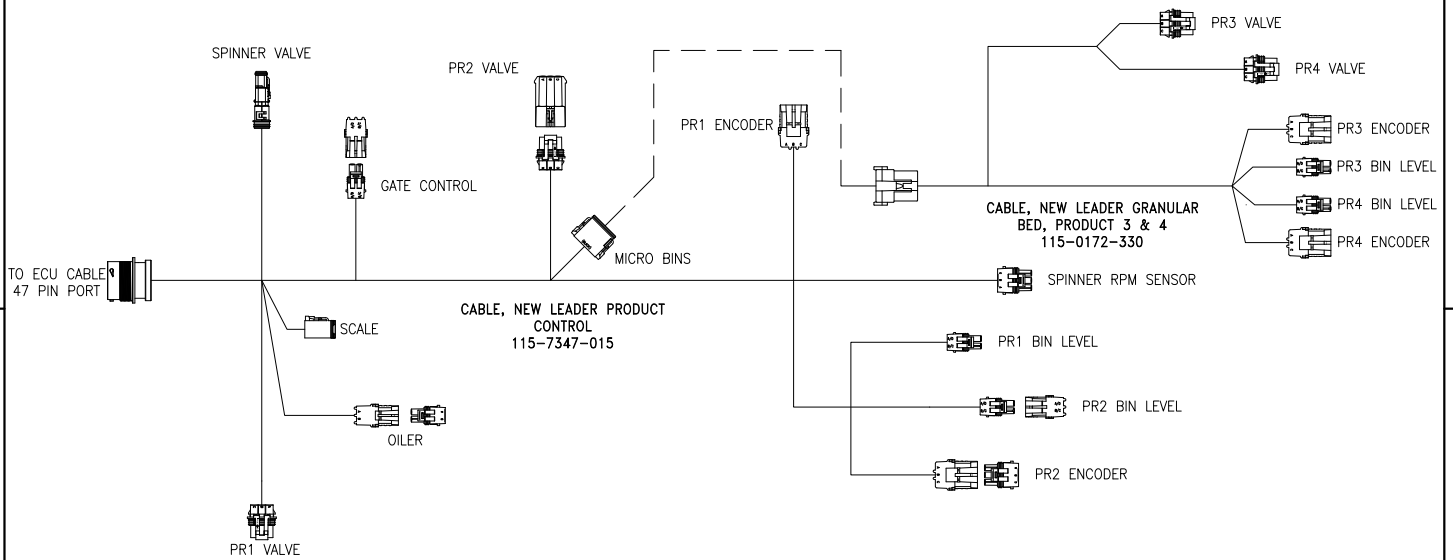

TEBBE SPREADER

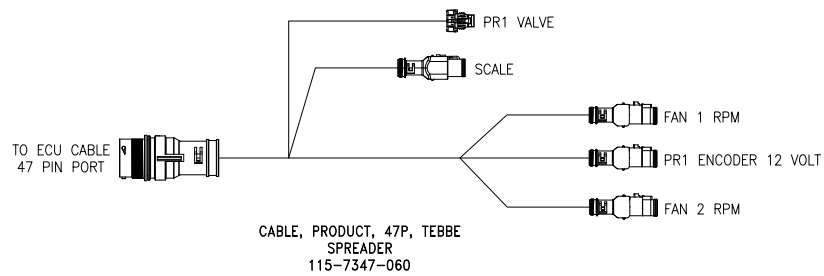

RELEASED DATE	ECO #	REV.	DRAWING NO.
8/29/17	29879	B	054-7100-003
9/14/17	29471	C	054-7100-003

RAVEN RCM AIR CART/GENERIC APPLICATOR OPTIONS

GENERIC PRODUCT HARNESS (1 PRODUCT, 10 SECTIONS)

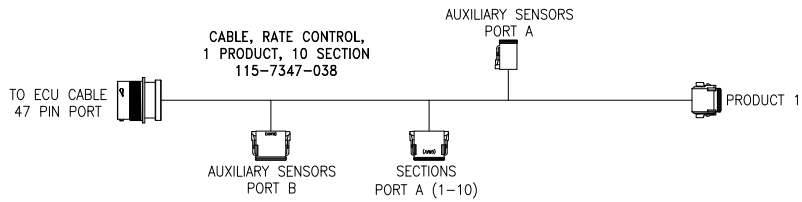

*NOTE: SEE PRODUCT CONTROL, SECTION CONTROL, & AUXILIARY SENSOR HARNESS OFFERINGS TO COMPLETE HARNESS CONFIGURATION.

SECTION CONTROL DRIVERS CAN BE CONFIGURED AS NEEDED FOR PRODUCTS VIA SETUP WIZARD.

GENERIC PRODUCT HARNESS (2 PRODUCT, 16 SECTIONS)

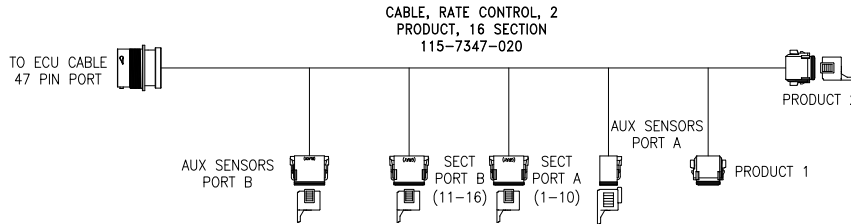

*NOTE: SEE PRODUCT CONTROL, SECTION CONTROL, & AUXILIARY SENSOR HARNESS OFFERINGS TO COMPLETE HARNESS CONFIGURATION.

SECTION CONTROL DRIVERS CAN BE CONFIGURED AS NEEDED FOR PRODUCTS VIA SETUP WIZARD.

GENERIC PRODUCT HARNESS (3 PRODUCT, 20 SECTIONS)

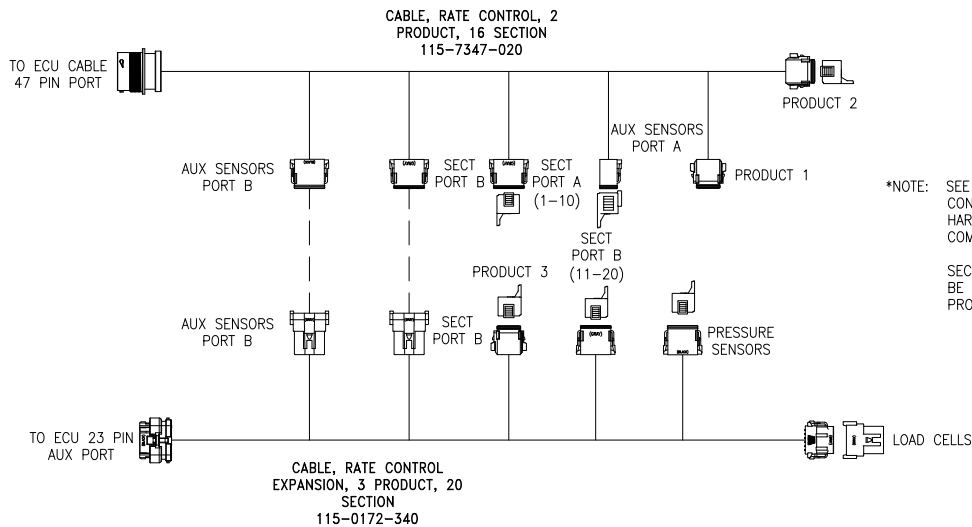

*NOTE: SEE PRODUCT CONTROL, SECTION CONTROL, & AUXILIARY SENSOR HARNESS OFFERINGS TO COMPLETE HARNESS CONFIGURATION.

SECTION CONTROL DRIVERS CAN BE CONFIGURED AS NEEDED FOR PRODUCTS VIA SETUP WIZARD.

GENERIC PRODUCT HARNESS (4 PRODUCT, 16 SECTIONS)

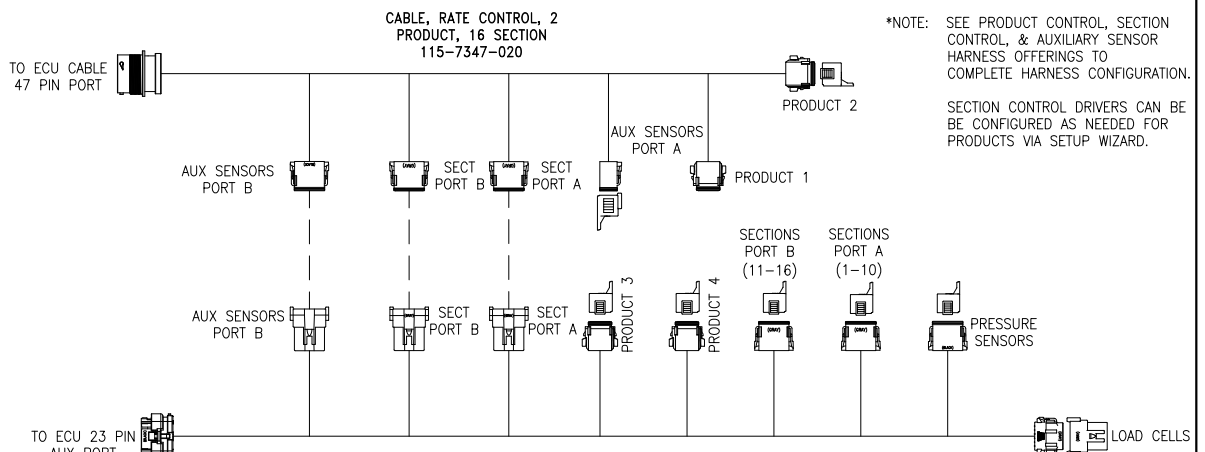

*NOTE: SEE PRODUCT CONTROL, SECTION CONTROL, & AUXILIARY SENSOR HARNESS OFFERINGS TO COMPLETE HARNESS CONFIGURATION.

SECTION CONTROL DRIVERS CAN BE CONFIGURED AS NEEDED FOR PRODUCTS VIA SETUP WIZARD.

CABLE, RATE CONTROL
EXPANSION, 4 PRODUCT, 16
SECTION
115-0172-341

RELEASED DATE	ECO #	REV.	DRAWING NO.
8/29/17	29879	B	054-7100-003
9/14/17	29471	C	054-7100-003

GENERIC PRODUCT HARNESS (5 PRODUCT, 10 SECTIONS)

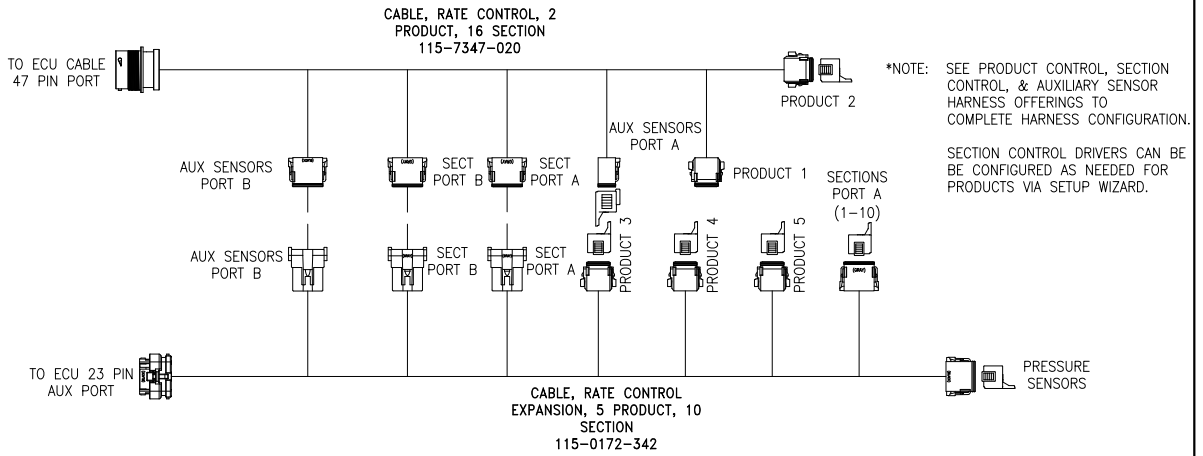

GENERIC PRODUCT HARNESS (5 PRODUCT, 12 SECTIONS)

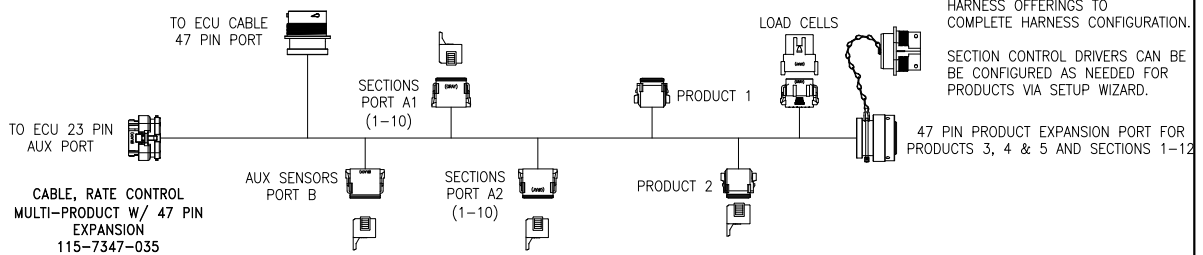

GENERIC PRODUCT HARNESS (2 PRODUCT, FULL WIDTH SECTIONS)

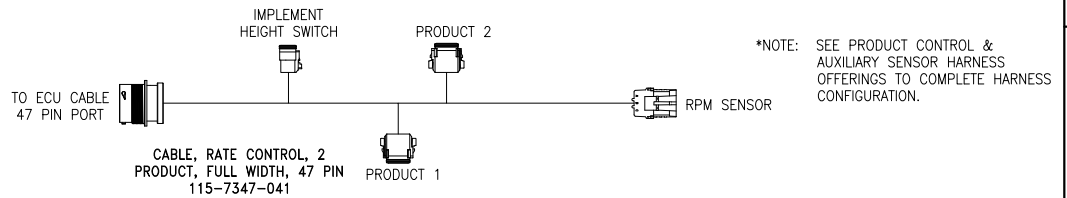

GENERIC PRODUCT HARNESS (5 PRODUCT, FULL WIDTH SECTIONS)

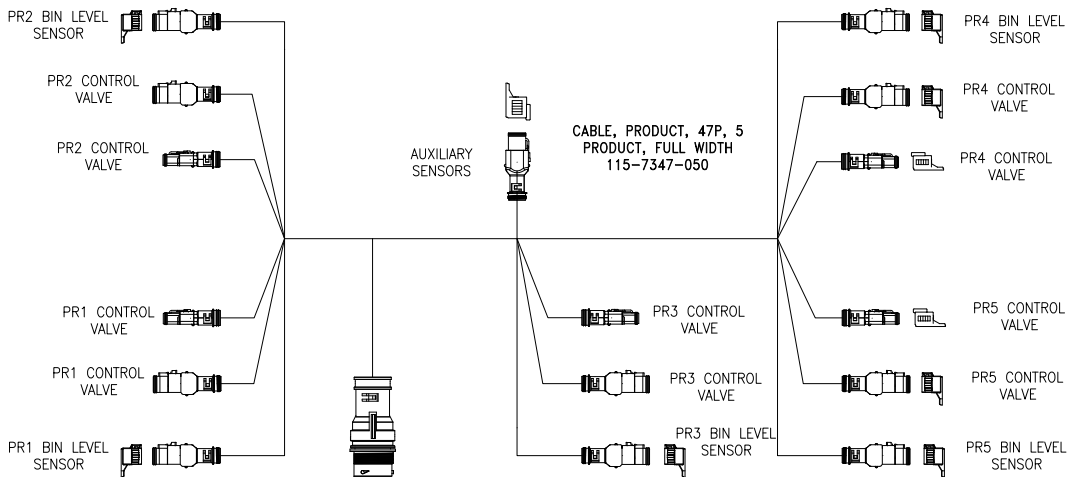

MACHINE SPECIFIC HARNESSES

CABLE, PRODUCT, 47 PIN, 4 PRODUCT, SEEDMASTER CART	115-7347-032
CABLE, PRODUCT, 47 PIN, HORSCH SW1000 CART	115-7347-036
CABLE, PRODUCT, 47 PIN, 3 PRODUCT, AMITY CART	115-7347-049
CABLE, PRODUCT, 47 PIN, 3 PRODUCT, ETS SOIL WARRIOR	115-7347-052

RELEASED DATE	ECO #	REV.	DRAWING NO.
8/29/17	29879	B	054-7100-003
9/14/17	29471	C	054-7100-003

PRODUCT PORT ADAPTER HARNESSES

CABLE, PRODUCT CONTROL, LIQUID, 10'
115-0172-350

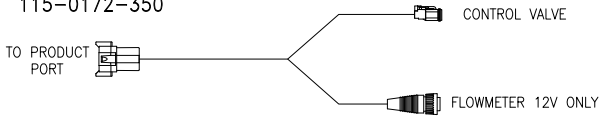

CABLE, PRODUCT CONTROL, GRANULAR, RAVEN MOTOR, 3P DT BIN LEVEL
115-0172-351

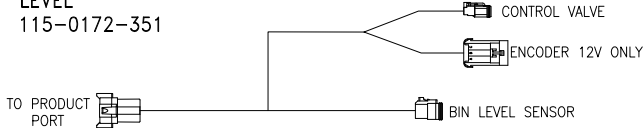

CABLE, PRODUCT CONTROL, GRANULAR, 10'
115-0172-352

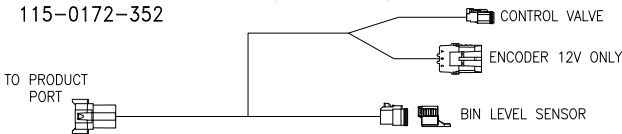

CABLE, PRODUCT CONTROL, GRANULAR, DEUTSCH DT CONNECTORS
115-0172-353

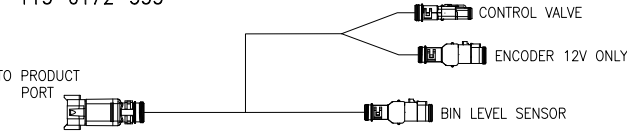

CABLE, PRODUCT CONTROL, GRANULAR, DEUTSCH DT CONNECTIONS, DUAL ENCODER
115-0172-354

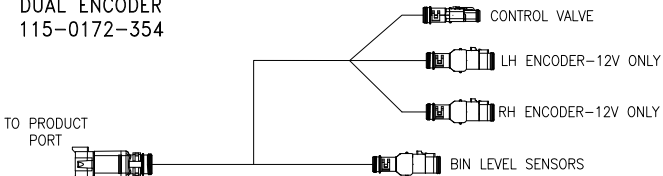

CABLE, PRODUCT CONTROL, GRANULAR, DEUTSCH DT CONNECTIONS, DUAL CONTROL VALVE
115-0172-364

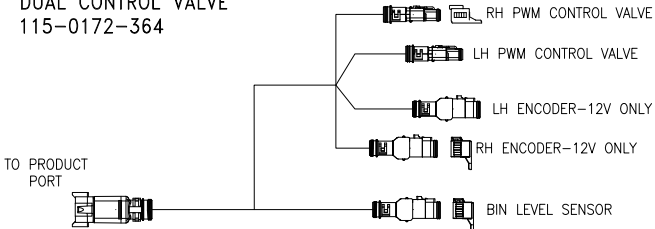

CABLE, ADAPTER, GENERIC RATE CONTROL
115-0172-379

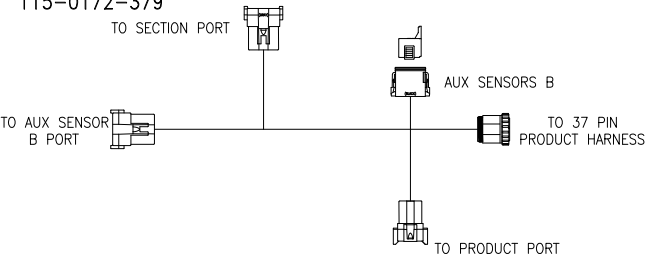

CABLE, 20' EXTENSION PRODUCT CONTROL
115-3001-118

SECTION CONTROL PORT ADAPTER HARNESSES

CABLE, SECTION CONTROL, 10 SECTION, DT, 10' 115-0172-345

CABLE, SECTION CONTROL, 10 SECTION, WP, 15' 115-0172-404

CABLE, SECTION CONTROL, 10 SECTION, BARE ENDS 115-3001-205

CABLE, SECTION CONTROL, 6 SECTION, DT, 10' 115-0172-346

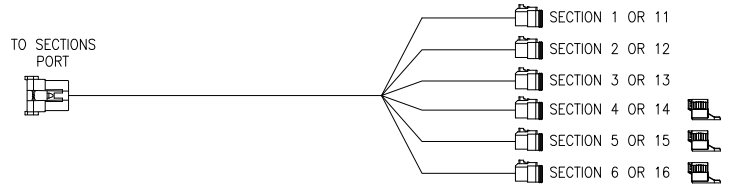

CABLE, 20' EXTENSION, SECTION CONTROL 115-0172-406

AUXILIARY SENSOR PORT ADAPTER HARNESSES

PORT A (6 PIN)

CABLE, ADAPTER, HEIGHT SWITCH SENSOR 115-0172-275

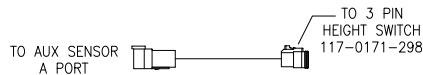

CABLE, ADAPTER, 2 RPM SENSORS, 6 PIN 115-0172-355

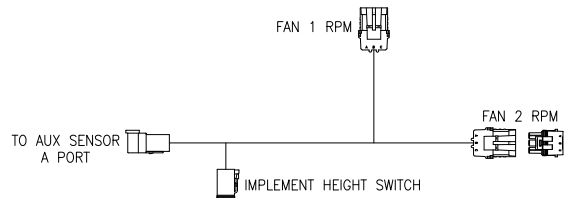

PORT B (12 PIN)

CABLE, ADAPTER, 2 PRESSURE, 2 SCALES 115-0172-356

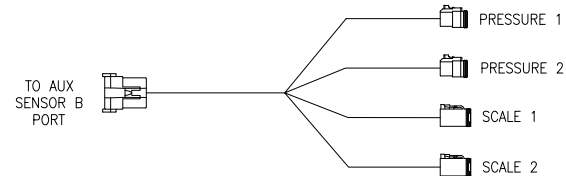

SCALES (12 PIN MINI)

CABLE, ADAPTER, 4 SCALES 115-0172-358

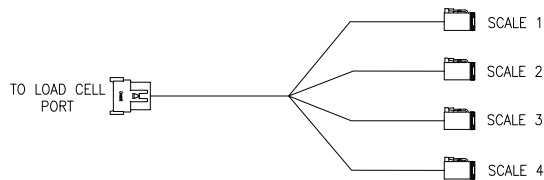

RELEASED DATE	ECO #	REV.	DRAWING NO.
8/29/17	29879	B	054-7100-003
9/14/17	29471	C	054-7100-003

RAVEN RCM ADAPTER HARNESSSES/ACCESSORIES

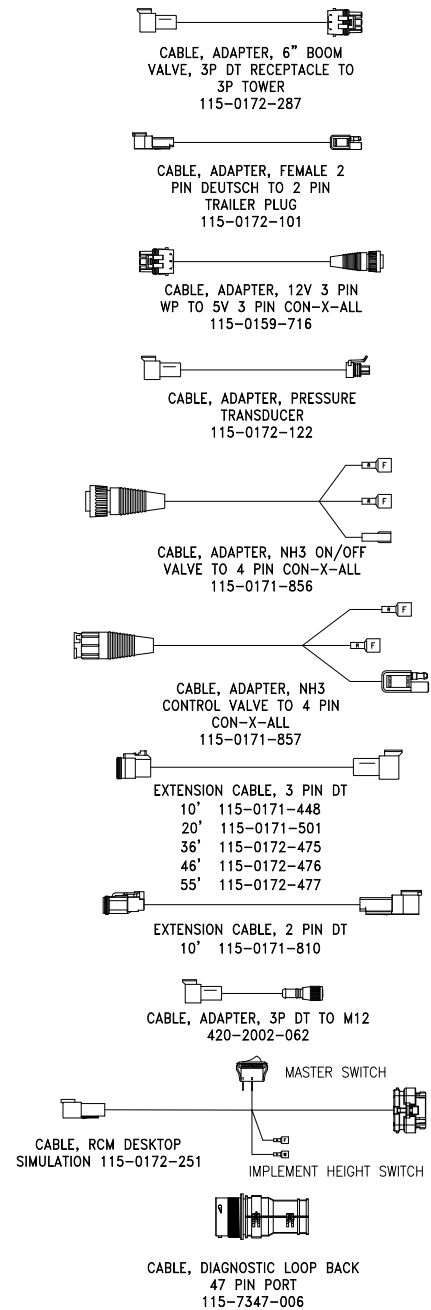
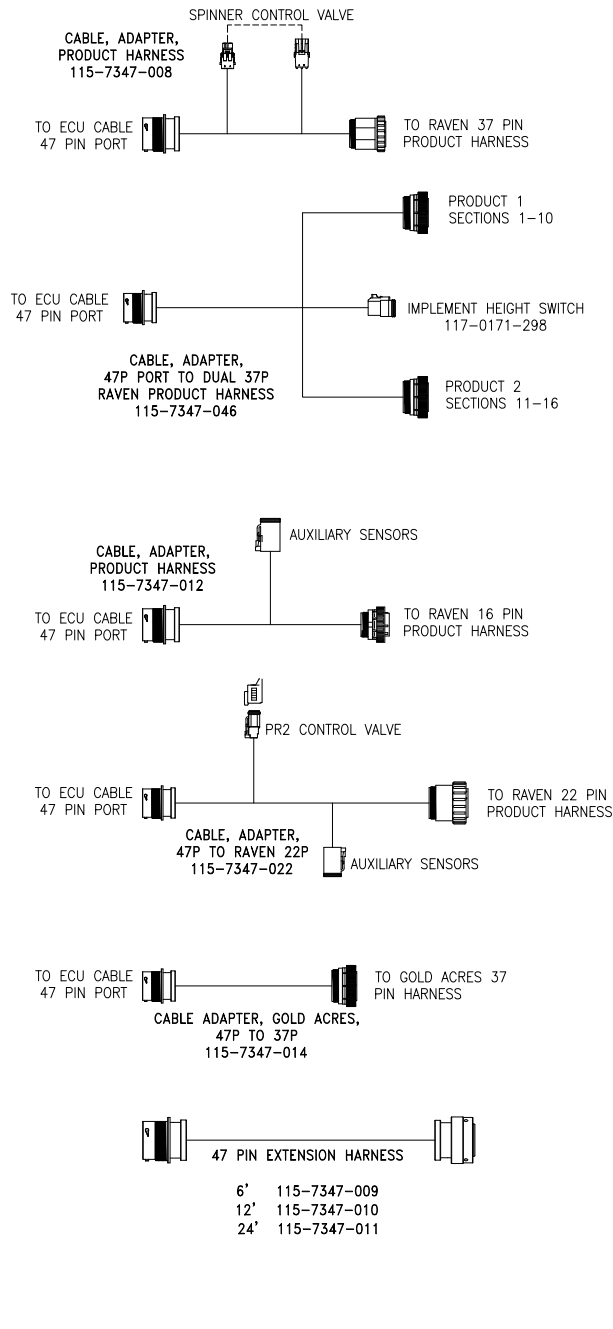

RELEASED DATE	ECO #	REV.	DRAWING NO.
8/29/17	29879	B	054-7100-003
9/14/17	29471	C	054-7100-003

LIQUID AUXILIARY SENSOR OPTIONS

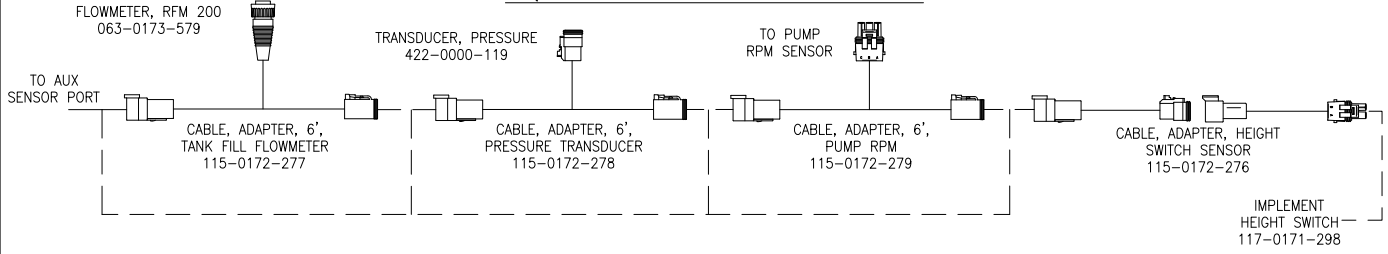

SENSOR OFFERINGS

BIN LEVEL SENSOR, 30MM

412-6000-008



BIN LEVEL SENSOR, 12MM

412-6000-015

ENCODER, 360 PPR, 12 VOLT, DT

063-0173-937

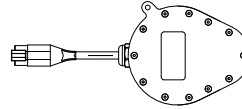

FAN/SPINNER RPM SENSOR, WEATHERPACK

117-0159-575



FAN/SPINNER RPM SENSOR, 12MM HOUSING, DT

412-6000-016

SHAFT/GEAR TOOTH SENSOR, 12MM HOUSING, DT

412-6000-016

HYDRAULIC PRESSURE TRANSDUCER, DT 0-3000 PSI

422-0000-093

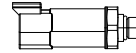

BIN PRESSURE SENSOR, DT, -55 TO 55 INCHES OF WATER

422-0000-125

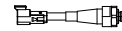

LIQUID PRESSURE SENSOR, DT, 0 TO 250 PSI

422-0000-119



RELEASED DATE	ECO #	REV.	DRAWING NO.
8/29/17	29879	B	054-7100-003
9/14/17	29471	C	054-7100-003